

99721

Dimensions

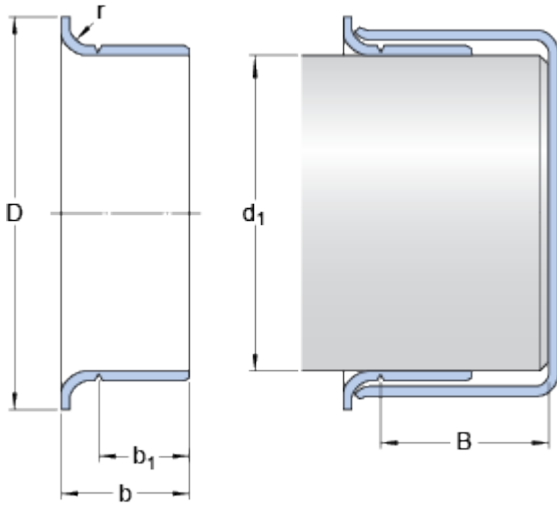

Nominal dimensions

d_1		180	mm
D		190.5	mm
Tolerance outside diameter D	\pm	1.6	mm
b		37.998	mm
Tolerance width b	\pm	0.8	mm
b_1		32.995	mm
Tolerance width b_1	\pm	0.8	mm
B	max.	44.501	mm
r	max.	3.18	mm

Shaft diameter range

d_1	min.	179.756	mm
d_1	max.	180.035	mm